

MCT 135 H6

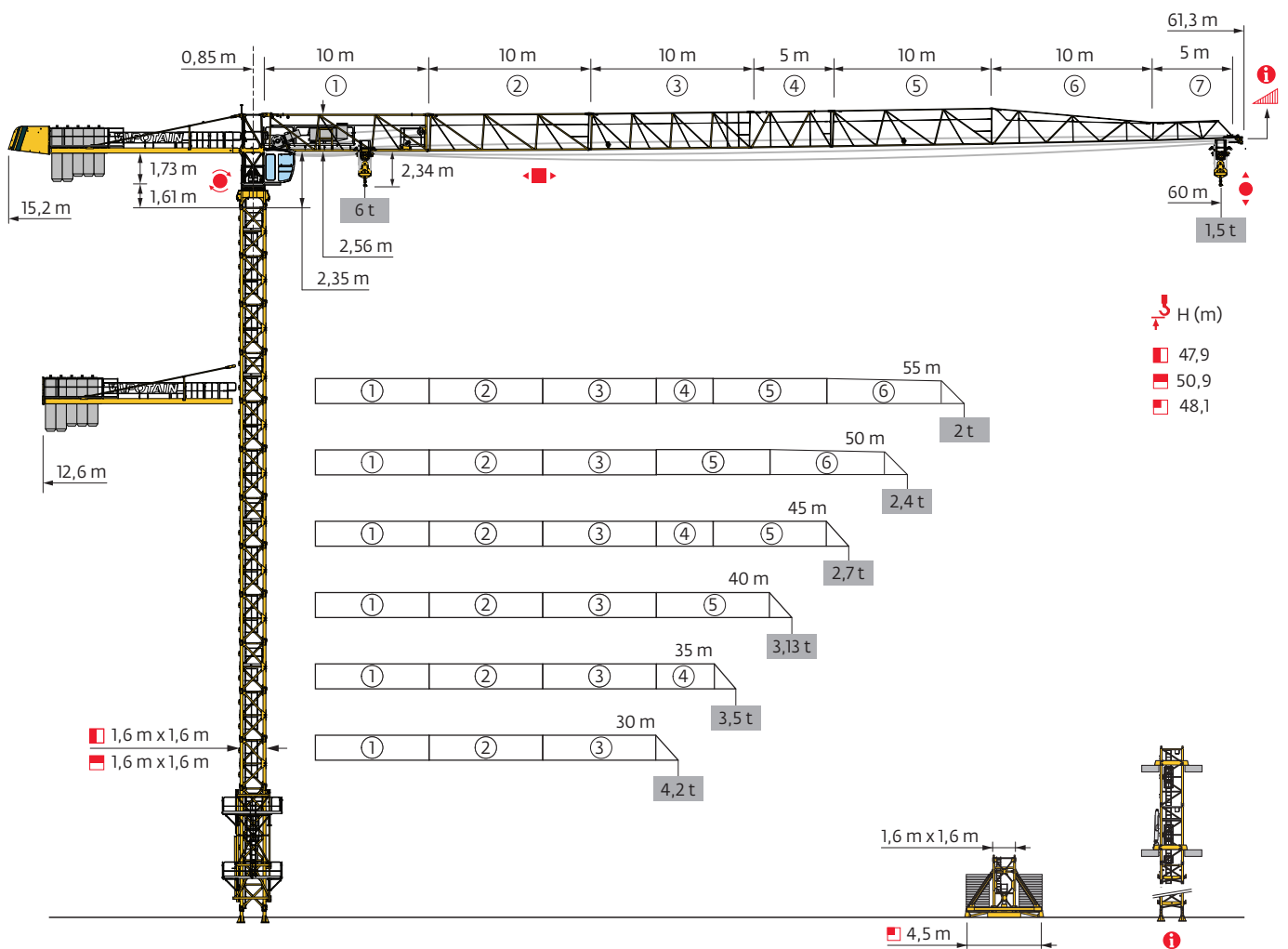

Mât - Réactions / Mast - Reaktionskräfte / Mast - Reactions / Mástil - Reacciones / Torre - Reazioni
 Tramo - Reacções / Реакция опор мачты

1,6 m - P 16A

ΔΔΔΔ (m)	30	35	40	45	50	55	60
Δ (m)	47,9	47,9	47,9	47,9	47,9	47,9	47,9
3,0 m	13	13	13	13	13	13	13
7,5 m (S 46J)	1	1	1	1	1	1	1
F2 (t)	● 99 ■ 129	99 130	100 129	102 130	103 131	105 134	107 138
F3 (t)	● 76 ■ 105	74 106	72 104	73 104	74 105	74 106	77 111

1,6 m - P 16A

ΔΔΔΔ (m)	30	35	40	45	50	55	60
Δ (m)	50,9	50,9	50,9	50,9	50,9	50,9	50,9
3,0 m	14	14	14	14	14	14	14
7,5 m (S 46JR)	1	1	1	1	1	1	1
F2 (t)	● 106 ■ 146	105 148	107 147	108 148	109 149	111 151	114 156
F3 (t)	● 82 ■ 122	80 123	78 121	78 121	80 122	80 123	83 128

1,6 m - SB 16A

ΔΔΔΔ (m)	30	35	40	45	50	55	60
Δ (m)	48,1	48,1	48,1	48,1	48,1	48,1	48,1
3,0 m	12	12	12	12	12	12	12
7,5 m (S 46J)	1	1	1	1	1	1	1
F1 (t)	● 64 ■ 82	65 82	64 81	65 81	65 82	66 83	69 87

1,6 m - BA 45A

ΔΔΔΔ (m)	30	35	40	45	50	55	60
Δ (m)	47,8	47,8	47,8	47,8	47,8	47,8	47,8
3,0 m	14	14	14	14	14	14	14
3,0 m (L 46C)	1	1	1	1	1	1	1
1,5 m (L 46F)	1	1	1	1	1	1	1

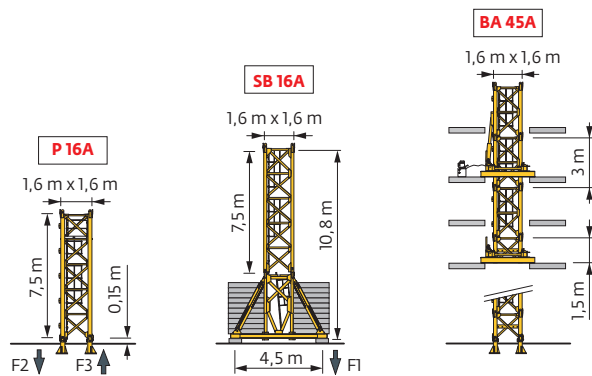

Télescopage sur dalles / Kletterkrane im Gebäude / Climbing Crane / Telescopage grua trepadora / Gru in cavedio
 Telescopagem sobre lages / Кран, ползущий внутри здания

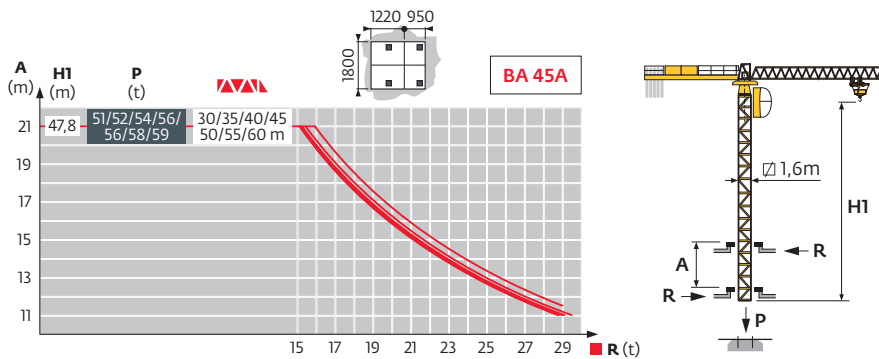

Ancrages / Verankerungen / Anchorages / Anclajes / Ancoraggi
 Ancoragem / Анкера

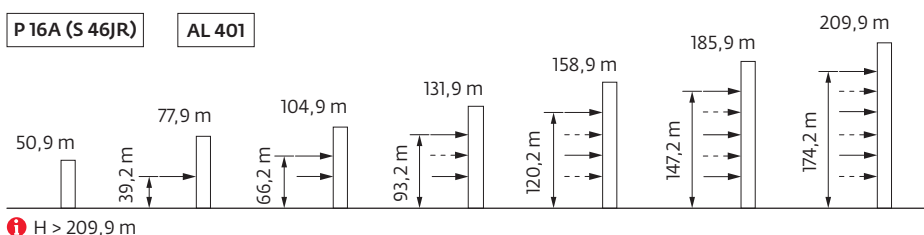
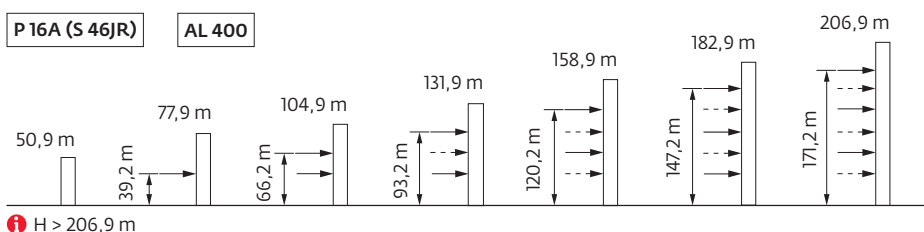
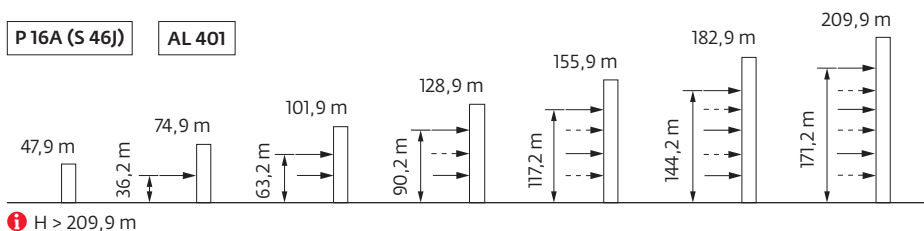
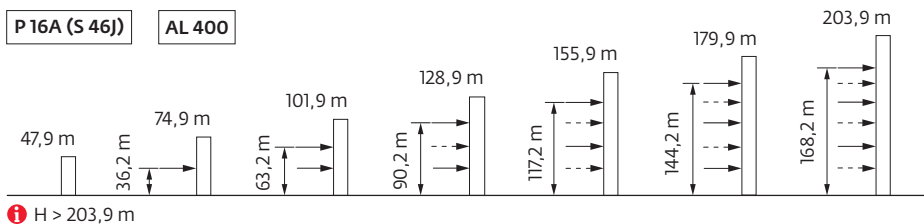

Courbes de charges / Lastkurven / Load curves / Curvas de cargas / Curve di carico
 Curvas de carga / Кривые нагрузок



(m)			17	20	22	25	27	30	32	35	37	40	42	45	47	50	52	55	57	60	m
	6 t																				
	3 t																				
60	2,0 → 19,3	34,5 → 35,2	6	5,8	5,2	4,4	4	3,6	3,3	3	2,8	2,55	2,4	2,2	2,1	1,9	1,85	1,7	1,6	1,5	t
55	2,0 → 21,7	38,9 → 40,0	6	6	5,9	5,1	4,7	4,1	3,8	3,4	3,2	3	2,8	2,6	2,45	2,25	2,15	2	t		
50	2,0 → 22,6	40,7 → 41,6	6	6	6	5,4	4,9	4,3	4	3,6	3,4	3,1	2,95	2,75	2,6	2,4	t				
45	2,0 → 22,4	40,4 → 41,3	6	6	6	5,3	4,8	4,3	4	3,6	3,3	3	2,95	2,7	t						
40	2,0 → 23,0		6	6	6	5,5	5	4,4	4,1	3,7	3,4	3,13	t								
35	2,0 → 22,1		6	6	6	5,2	4,8	4,2	3,9	3,5	t										
30	2,0 → 22,1		6	6	6	5,2	4,8	4,2	t												

= - 0,08 t max

Lest de base / Grundballast / Base ballast / Lastre de base / Zavorra di base
 Lastro da base / Базовый Балласт

☰ (t) / 1,6 m - SB 16A - ☱							
☱ (m)	30	35	40	45	50	55	60
48,1	84	84	78	78	78	78	84
45,1	66	66	60	60	60	60	66
42,1	48	48	48	48	48	48	54
39,1	42	42	42	42	42	48	48
36,1	42	42	42	42	42	48	48
33,1	36	42	42	42	42	42	42
30,1	36	36	36	36	36	42	42
27,1	36	36	36	36	36	36	42
24,1	30	36	36	36	36	36	36
21,1	30	30	30	30	30	36	36
18,1	30	30	30	30	30	30	36
15,1	30	30	30	30	30	30	30

Poids de flèche & lest de contre-flèche / Auslegergewicht & Gegenauslegerballast / Jib weight & counter-jib ballast / Peso de flecha y lastre de contra-flecha / Peso del braccio & zavorra di contro-braccio / Peso da lança & lastro da contra lança
 Вес стрелы и балласт контр-стрелы

33 LVFC ☱				
☱	2250 kg	3450 kg	3700 kg	☱ (kg)
60 m	0	3	2	17750
55 m	0	3	2	17750
50 m	1	4	0	16050
45 m	1	4	0	16050
40 m	0	3	1	14050
35 m	1	2	1	12850
30 m	2	1	1	11650

CCB 3700 kg

(cm)

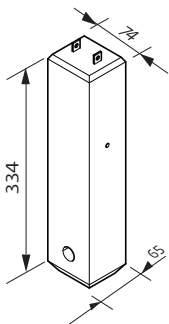

CD 3450 kg

(cm)

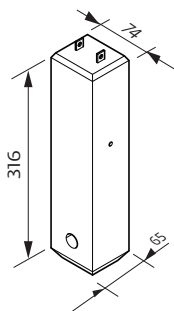

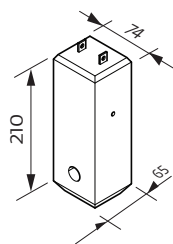

CE 2250 kg

(cm)





Encombremet et poids / Abmessungen und Gewicht / Dimensions and weight / Dimensiones y peso / Ingombro e peso
dimensões e pesos / габаритные размеры и вес

Partie tournante / Drehender Kranteil / Slewing crane part / Parte giratoria

Parte rotante / Parte rotativa / Поворотная часть :  60 m -  -  33 LVFC 15

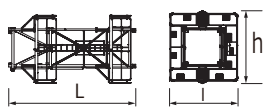
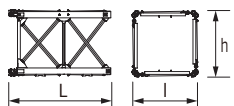
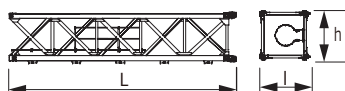
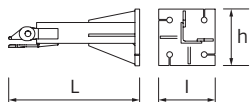
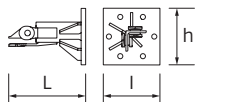
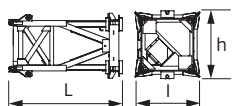

Partie tournante / Drehender Kranteil / Slewing crane part Parte giratoria / Parte rotante / Parte rotativa Поворотная часть		L (m)	l (m)	h (m)	kg (+/-5%)	
Contre-flèche / Gegenausleger Counter-jib / Contra-flecha Controbraccio / Contra-lança Контр-стрела		14,47	1,64	1,74	2620	
cabine / Kabine cab / cabina cabina / cabina кабина	S110	3,01	1,81	2,54	650	
	S120	3,05	1,81	2,51	650	
Pivot / Krankopf Towerhead / Pivote Portaralla / Pivot Секция поворотной части	RCV145	2,33	2,1	2,06	3054	
	RVF152	2,08	2,1	2,06	2893	
Treuil de levage (+ câble) / Hubwerk (+ Seil) Hoisting winch (+ rope) / Mecanismo de elevación (+ cabo) Argano di sollevamento (+ fune) Guincho de elevação (+ cabo) Подъемная лебедка (+ канатом)	33 LVFC 15	1,75	1,32	0,76	840	
Elément de flèche / Auslegerelement Jib section / Elemento de flecha Elemento di braccio / Elemento de lança Секция стрелы	①	10,33	2,30	2,56	2287	
		②	10,2	1,05	2,34	1321
		③	10,16	1,05	2,31	1195
		⑤	10,1	1,05	2,28	613
	④	5,13	1,05	2,28	418	
	⑥	10,08	1,05	2,25	409	
	⑦	5,04	1,05	1,14	177	
	⑧	1,52	1,57	0,61	94	
Chariot / Laufkatze Trolley / Carrello Carro / Carro-distribuidor Тележка	SM/DM	1,45	1,36	0,81	204	
Moufle / Hubflasche Pulley block / Aparejo Bozzello / Cadernal Полиспасть		0,78	0,18	1,58	203	

Equipement de télescope / Teleskopierausrüstung / Telescoping equipment Equipo de telescopaje / Equipaggiamento di telescopaggio / Equipamento de telescopagem Оборудование для телескопирования		L (m)	l (m)	h (m)	kg (+/- 5%)	
Cage de télescope / Teleskopwagen Telescopic cage / Jaula de telescopaje Gabbia di telescopaggio / Gaiola de telescopagem для телескопирования крана		$\square 1,6m$ 6,8	3,65	3,6	3610	
Mât / Mastwerk / Masts Mástil / Torre / Coluna Мачты						
L 46A3		3,24	1,67	1,72	1180	
S 46J		7,74	1,73	1,68	2592	
S 46JR		7,74	1,73	1,68	3060	
Bases / Kranbasen / Crane bases Bases / Basi / Bases фундамент под кран						
Pieds de scellement / VerankerungsfüÙe Fixing angles / Pie de empotramiento Montante da annegare / Angulos fixadores анкера		P 16A	1,14	0,49	0,49	185
		R 16A	0,69	0,5	0,5	145
Mât-châssis / Grundmasteinheit Basic mast unit / Tramo-chasis Elemento base / Tramo-chassis Мачта для крепления к шасси		SB 16A	3,61	1,96	1,96	2645
Haubans / Mastabstützungen Struts / Tornapuntas Puntoni / Escoras Растяжка		SB 16A	3,18	0,24	0,25	230
Sommier / Unterwagenhälfte Half-bearer / Testero Testata / Estrutura base Траверса		SB 16A	5,08	0,61	1,79	1115

Mécanismes / Triebwerke / Mechanisms / Mecanismos / Meccanismi
 Mecanismos / Механизмы

400 V - 50 Hz											ch - PS hp	kW	
	33 LVFC 15	m/min	36	53	72	102	18	26,5	36	51	33	22	400m
		t	3	2,25	1,5	0,75	6	4,5	3	1,5			
	RCV 145	tr/min U/min -rpm	0 → 0,8								2 x 6	2 x 4,4	
	RVFC 152 Optima+	tr/min U/min -rpm	0 → 0,76								2 x 5,5	2 x 4	
	RVF 152 Optima+	tr/min U/min -rpm	0 → 0,76								2 x 5,5	2 x 4	
	4 D3 V 4	m/min	15 → 30 → 58								4	3	
	6 DVFC 4-2	m/min	0 → 80								5,5	4,0	

IEC 60204-32	kVA
400 V (+10% -10%) 50 Hz	33 LVFC : 41 kVA

480 V - 60 Hz											ch - PS hp	kW	
	33 LVFC 15	m/min	36	53	72	102	18	26,5	36	51	33	22	400m
		t	3	2,25	1,5	0,75	6	4,5	3	1,5			
	RCV 145	tr/min U/min -rpm	0 → 0,96								2 x 7,2	2 x 5,3	
	RVFC 152 Optima+	tr/min U/min -rpm	0 → 0,76								2 x 5,5	2 x 4	
	RVF 152 Optima+	tr/min U/min -rpm	0 → 0,76								2 x 5,5	2 x 4	
	4 D3 V 4	m/min	18 → 36 → 70								4,8	3,6	
	6 DVFC 4-2	m/min	0 → 80								5,5	4,0	

IEC 60204-32	kVA
480 V (+6% -10%) 60 Hz	33 LVFC : 42 kVA

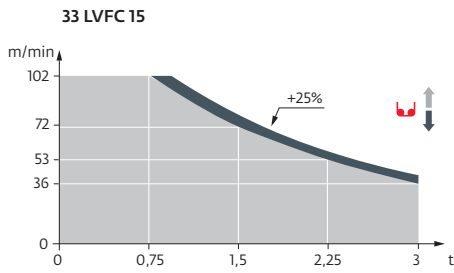

	FR	DE	EN	ES	IT	PT	RU
	Appel de flèche	Auslegerüberhöhung	Jib elevation	Elevación de la flecha	Inclinazione braccio	Desvio da lança	подъем стрелы
	Réactions en service	Reaktionskräfte in Betrieb	Reactions in service	Reacciones en servicio	Reazioni in servizio	Reacções em serviço	Реакция при работе
	Réactions hors service	Reaktionskräfte außer Betrieb	Reactions out of service	Reacciones fuera de servicio	Reazioni fuori servizio	Reacções fora de serviço	Реакция в покое
	Poids total du lest	Ballast-Gesamtgewicht	Total ballast weight	Peso total del lastre	Peso totale della zavorra	Peso total do lastro	Общий вес балласта
	Camion 13,4 m	Lkw 13,4 m	Lorry 13,4 m	Camión 13,4 m	Camion 13,4 m	Camião 13,4 m	Ррузовой автомобиль 13,4 м
	Conteneur High Cube 40°	Container High Cube 40°	Container High Cube 40°	Contenedor High cube 40°	Container High Cube 40°	Contentor 40°	Контейнер повышенной вместимости длиной 40°
	Cadre d'ancrage serré	Fester Verankerungsrahmen	Tightened anchorage frame	Marco de anclaje de apriete	Quadro di ancoraggio stretto	Quadro de amarração apertado	Прикрепленная анкерная рама
	Cadre d'ancrage desserré	Loser Verankerungsrahmen	Loosened anchorage frame	Marco de anclaje de desapriete	Quadro di ancoraggio allentato	Quadro de amarração solto	Отсоединенная анкерная рама
	Levage	Heben	Hoisting	Elevación	Sollevamento	Elevação	Подъем
	Distribution	Katzfahren	Trolleying	Distribución	Distribuzione	Distribuição	Перемещение по стреле
	Orientation	Schwenken	Slewing	Orientación	Rotazione	Rotação	Поворот
	Tranlation	Kranfahren	Travelling	Traslación	Traslazione	Translação	Перемещение крана
	Puissance requise	Erforderliche Leistung	Required power	Potencia Necesaria	Potenza richiesta	Potência Necessária	Потребляемая мощность
	Fonction Power Control : vitesses treuils adaptées à la puissance disponible	Funktion Power Control: Geschwindigkeiten der Triebwerke werden an die verfügbare Leistung angepasst	Power Control Function: winch speeds adapted to the available power	Función Power Control: marchas de los cabrestantes adaptadas a la potencia disponible	Funzione Power Control: velocità degli argani adattate alla potenza disponibile	Função Power Control: velocidades de guincho adaptadas à potência disponível	Функция контроля мощности Power Control: регулировка скорости лебедок в зависимости от доступной мощности
	Nous consulter	AufAnfrage	Consult us	Consultarnos	Consultateci	Consultar-nos	Проконсультируйтесь у нас
	Document commercial non contractuel. Pour toute information technique se référer à la notice correspondante.	Unverbindliches Vertriebsdokument. Für technische Informationen, siehe die entsprechenden Anweisungen.	This commercial document is not legally binding. For any technical information, please refer to the corresponding instructions.	Documento comercial no contractual. Para cualquier información técnica, ver la noticia correspondiente.	Documento commerciale non vincolante, per tutte le informazioni tecniche fare riferimento al catalogo istruzioni.	Documento comercial não contractual. Para qualquer informação técnica complementar consultar as respectivas instruções.	Этот коммерческий документ не является юридически обязательным. Для получения технической информации, см. соответствующие инструкции.

